

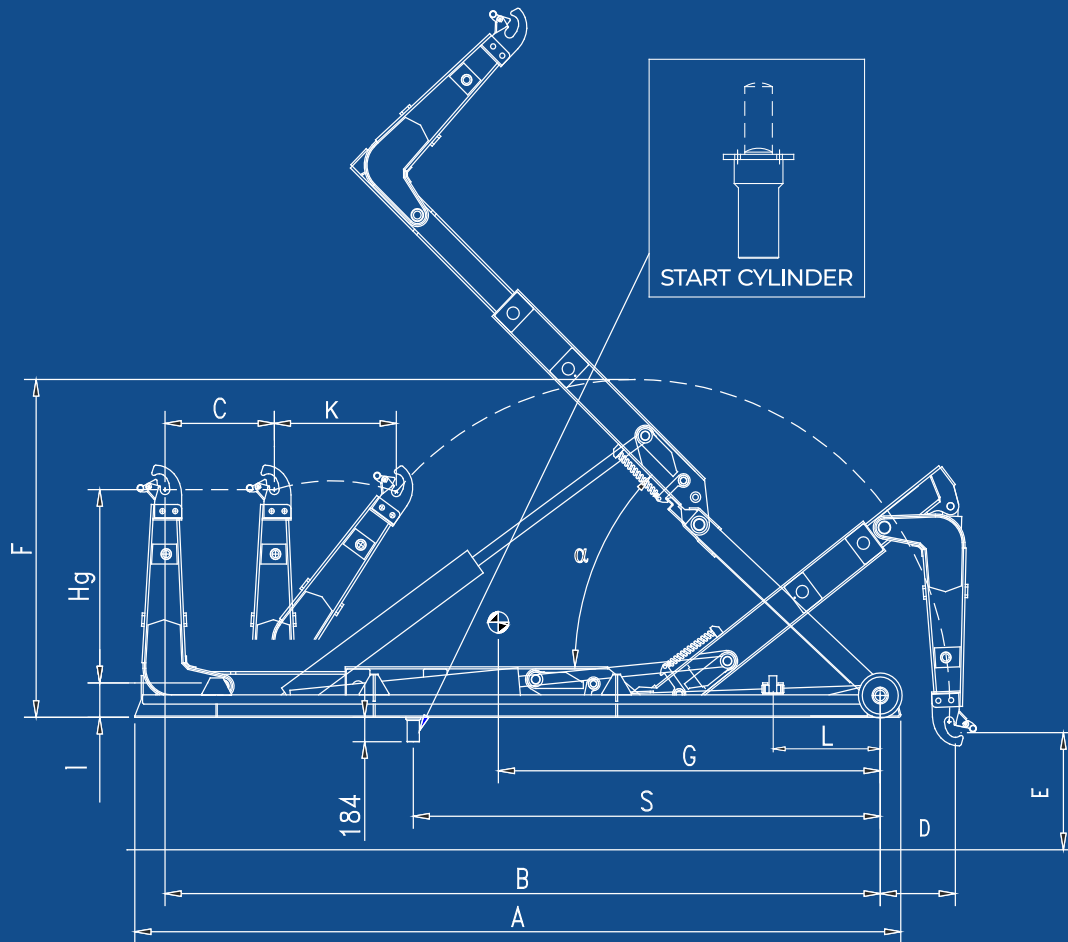

TA35 HD



TA35 HD

MODEL	HG	A	B	C	D	E	F	G	I	K	L	S	WEIGHT	α	CONTAINER	
															MIN	MAX
TA32 N HD	1425/1570	5500	5160	850	1000	200	2550	2950	240	950	500	3130	3450 kg	51°	3800	5800
TA32 NL HD	1425/1570	5750	5360	850	800	200	2550	3100	240	950	700	3330	3500 kg	48°	4000	6000
TA32 L HD	1425/1570	5950	5560	850	600	200	2550	3250	240	950	900	3530	3550 kg	45°	4200	6200

TAL35 HD

MODEL	HG	A	B	C	D	E	F	G	I	K	L	S	WEIGHT	α	CONTAINER	
															MIN	MAX
TAL 32 NC HD	1425/1570	6360	5950	1150	1050	200	2780	3300	280	950	700	3900	3600 kg	55°	4400	6600
TAL 32 N HD	1425/1570	6560	6150	1150	850	200	2780	3450	280	950	900	4100	3650 kg	52°	4600	6800
TAL 32 NL HD	1425/1570	6760	6350	1150	650	200	2780	3600	280	950	1100	4300	3700 kg	49°	4800	7000
TAL 32 L HD	1425/1570	6790	6550	1150	450	200	2780	3750	280	950	1300	4500	3750 kg	46°	5000	7200