

# R 130 S2L

EDIT 220620

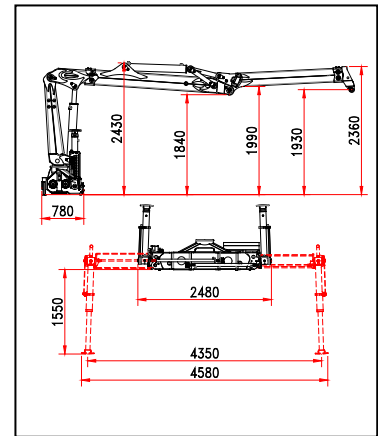
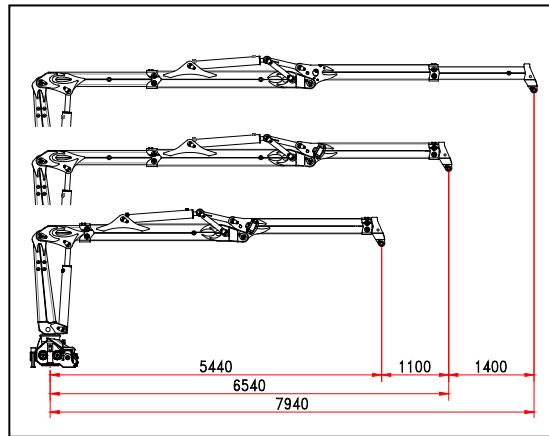
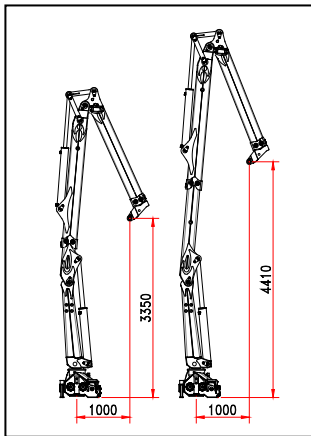
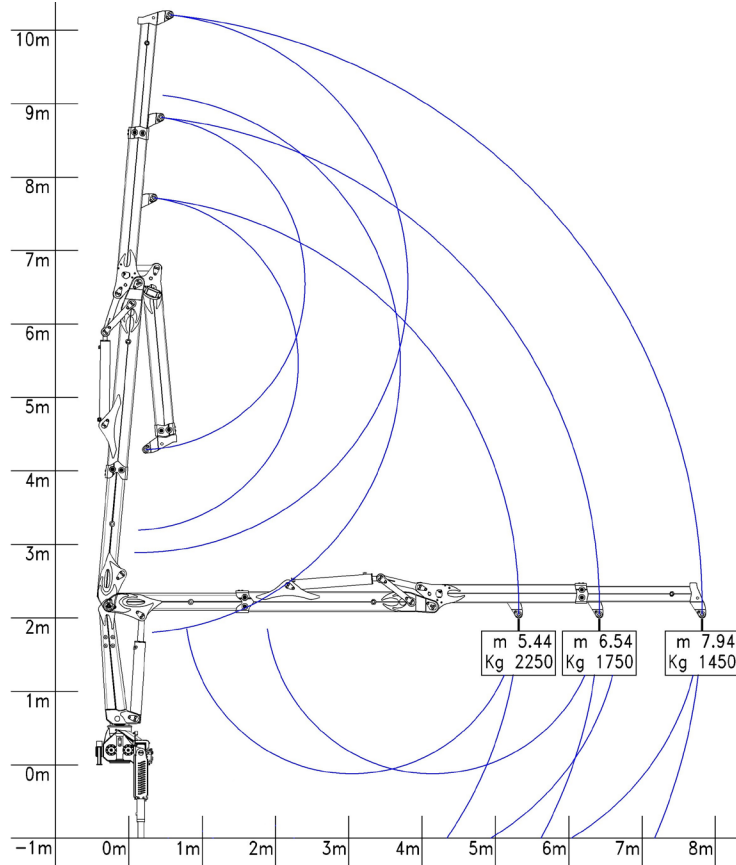

<b>Lifting moment</b>	130 KNm	<b>Pump capacity</b>	1x80 l/min
<b>Max outreach</b>	7,94 m	<b>Double pump (OPT.)</b>	2x70 l/min
<b>Rotation</b>	425°	<b>Pressure max</b>	230 bar
<b>Rotation torque</b>	28 kNm	<b>Weight</b>	2460 kg

CRANE DESIGNED ACCORDING TO STANDARDS UNI EN 12999 HC1 HD4 S4 (EX DIN 15018 H1B4)