

W 110 S3

EDIT 220620

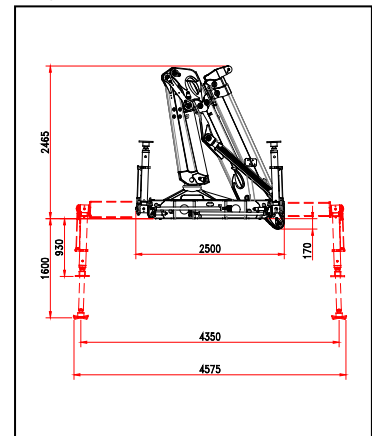
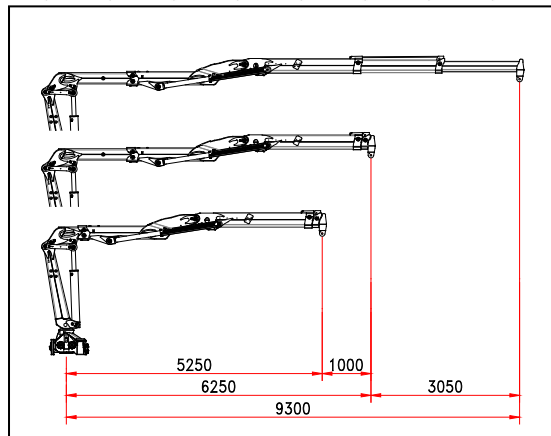
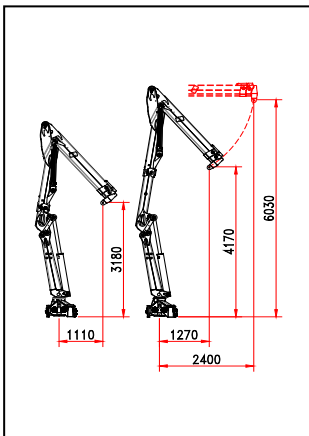
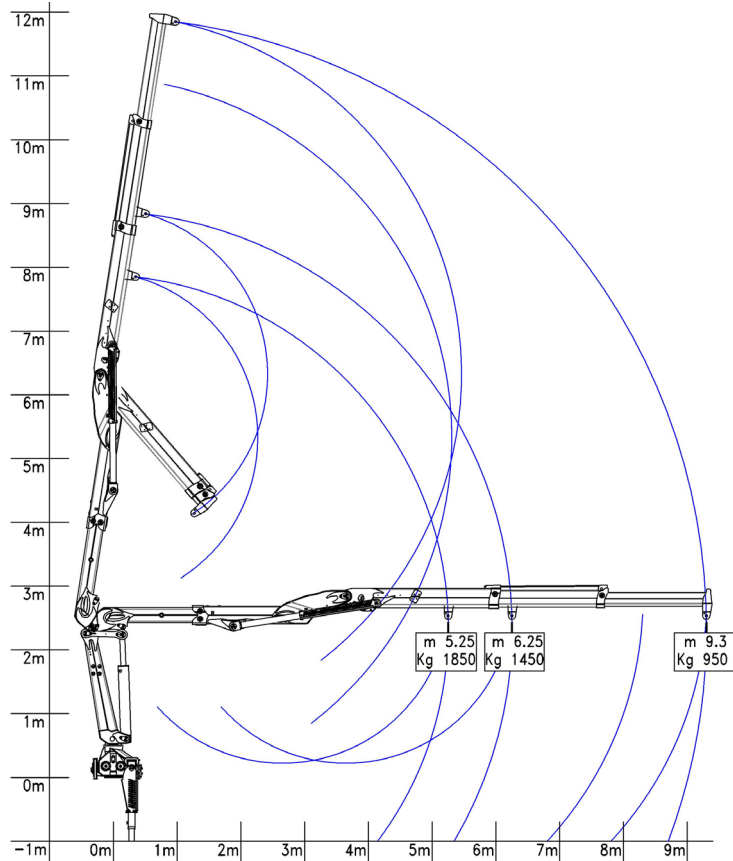

Lifting moment	110 KNm	Pump capacity	1x80 l/min
Max outreach	9,30 m	Double pump (OPT.)	2x70 l/min
Rotation	425°	Pressure max	230 bar
Rotation torque	27 kNm	Weight	2670 kg

CRANE DESIGNED ACCORDING TO STANDARDS UNI EN 12999 HC1 HD4 S4 (EX DIN 15018 H1B4)