

W 130 S2

EDIT 220620

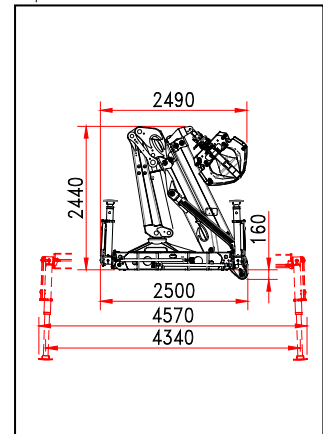
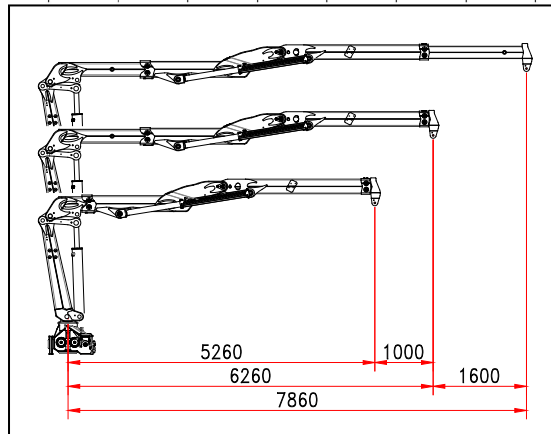
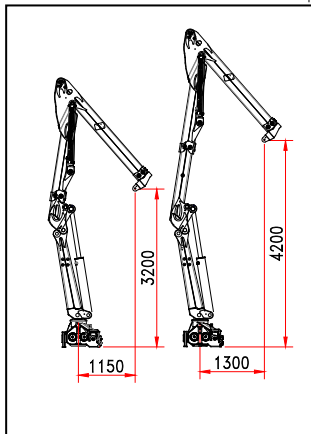
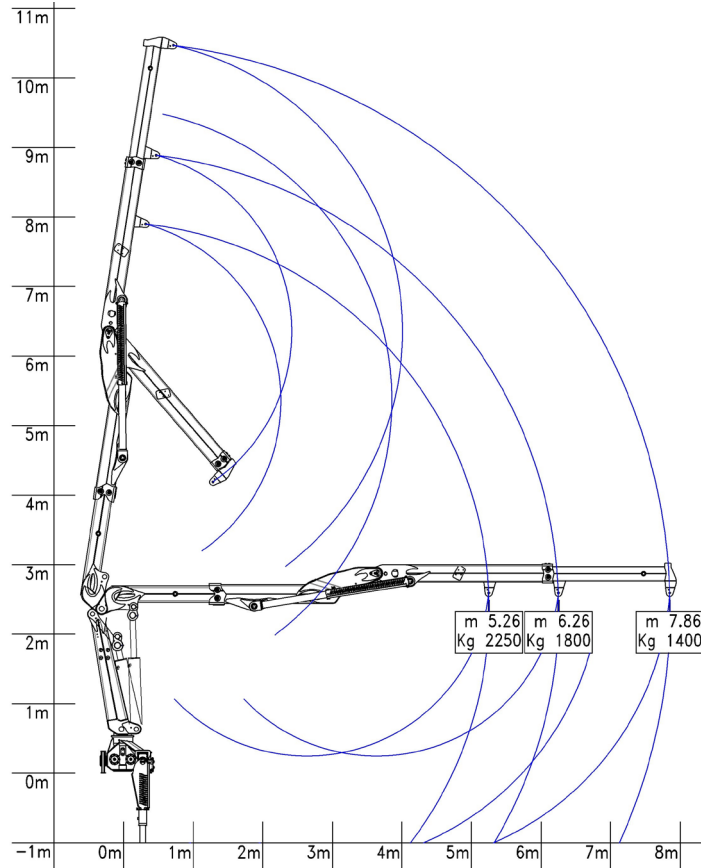

Lifting moment	130 KNm	Pump capacity	1x80 l/min
Max outreach	7,86 m	Double pump (OPT.)	2x70 l/min
Rotation	425°	Pressure max	230 bar
Rotation torque	28 kNm	Weight	2630 kg

CRANE DESIGNED ACCORDING TO STANDARDS UNI EN 12999 HC1 HD4 S4 (EX DIN 15018 H1B4)