

W 150 S2

EDIT 220620

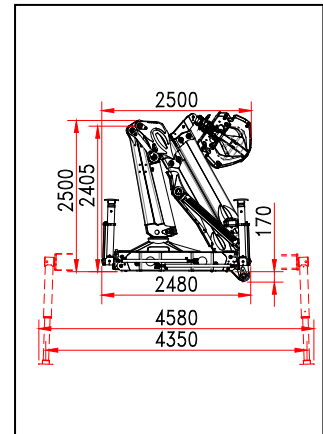
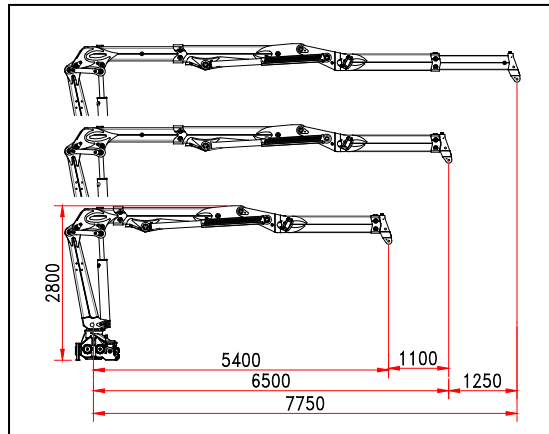
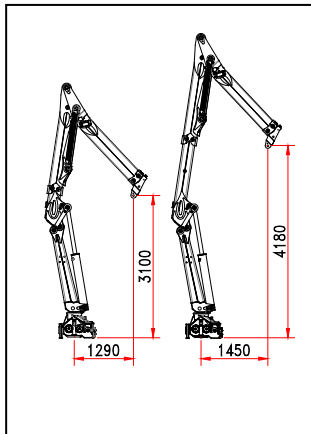
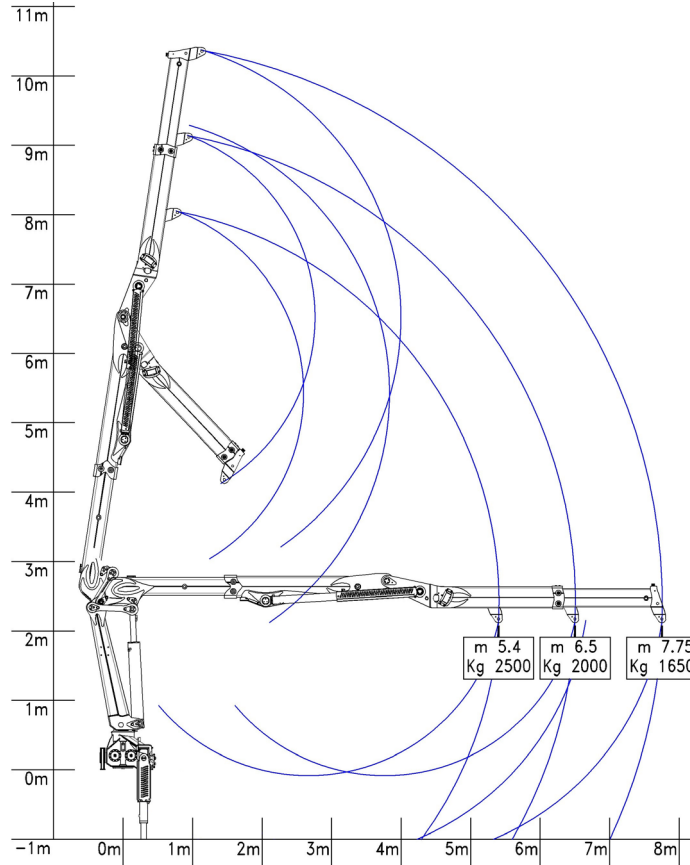

Lifting moment	150 KNm	Pump capacity	1x80 l/min
Max outreach	7,75 m	Double pump (OPT.)	2x70 l/min
Rotation	425°	Pressure max	250 bar
Rotation torque	30 kNm	Weight	3130 kg

CRANE DESIGNED ACCORDING TO STANDARDS UNI EN 12999 HC1 HD4 S4 (EX DIN 15018 H1B4)